

① x1

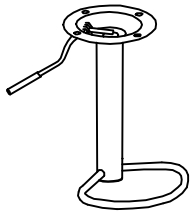

② x1



1

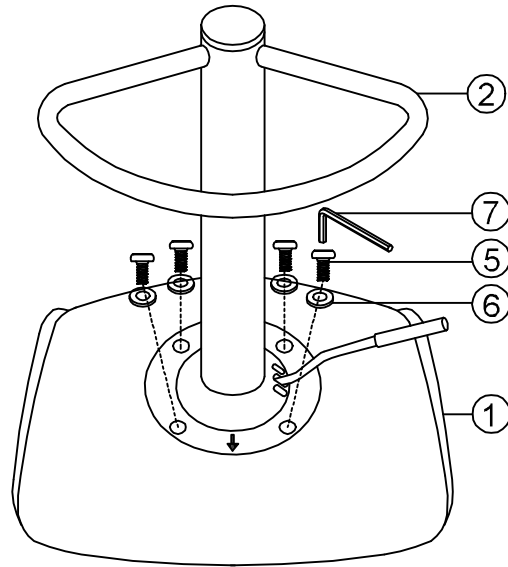

2

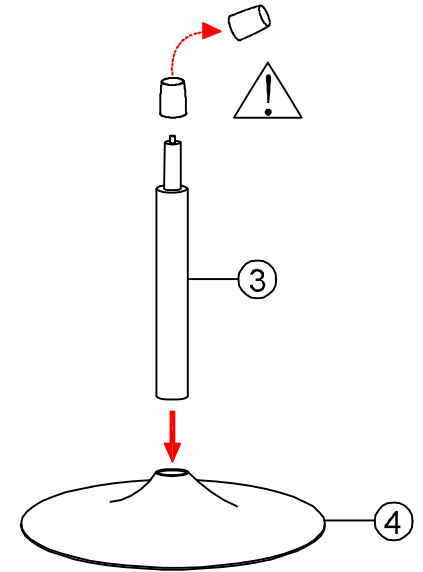

③ x1

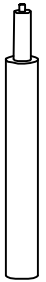

④ x1

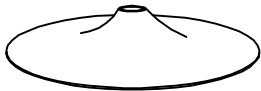

3

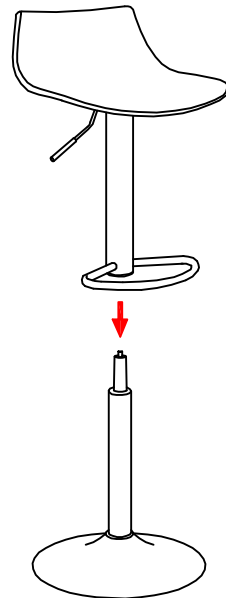

4

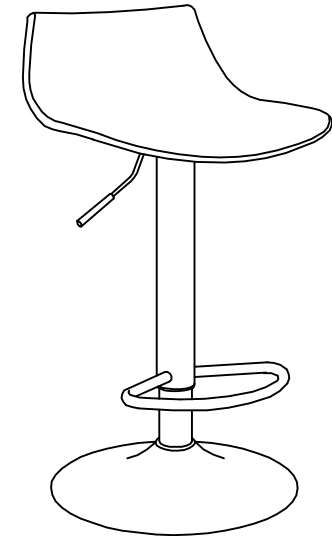

⑤ x4

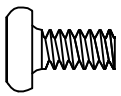

M6x10mm

⑥ x4

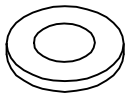

M6x15x1.2mm

⑦ x1

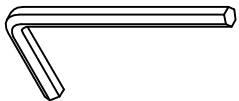

M5