

OMBRA

design GEA AVITABILE



L'ombra è l'alone che un oggetto proietta e che ne espande la presenza. Le ombre fanno parte del nostro vivere quotidiano, ci infondono sicurezza, e qualche volta un riparo. Spesso un'ombra mette in luce dettagli altrimenti non visibili. A questo si ispirano le geometrie della collezione OMBRA, una piccola architettura che dialoga con lo spazio circostante.

A shadow is the halo around an object that extends its presence. Shadows are part of our everyday lives, giving us security and sometimes protection. Often a shadow highlights details that would otherwise be invisible. This is the inspiration behind the geometry of the OMBRA series, a small piece of architecture in dialogue with the space around it.

OMBRA

design GAE AVITABILE

1P / 1S



ANGOLO / CORNER



2P / 2S



3P / 3S



POUF



OMBRA

design GAE AVITABILE

1P / 1S

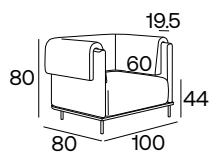

100 cm / 39.37"
80 cm / 31.50"
80 cm / 31.50"
44 cm / 17.13"
60 cm / 23.62"
19.5 cm / 7.68"

 30 kg / 67 Lb

 0.66 m³

 10.50 mtl
tessuto cliente /
customer fabric
H 140 cm

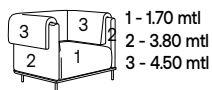

1 - 1.70 mtl
2 - 3.80 mtl
3 - 4.50 mtl

19.53 m²
pelle cliente /
customer pelle

2P / 2S

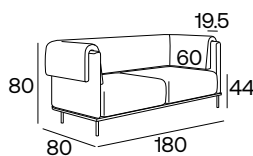

180 cm / 70.87"
80 cm / 31.50"
80 cm / 31.50"
44 cm / 17.13"
60 cm / 23.62"
19.5 cm / 7.68"

 55 kg / 122 Lb

 1.19 m³

 15.00 mtl
tessuto cliente /
customer fabric
H 140 cm

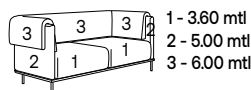

1 - 3.60 mtl
2 - 5.00 mtl
3 - 6.00 mtl

27.90 m²
pelle cliente /
customer pelle

3P / 3S

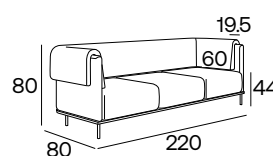

220 cm / 86.61"
80 cm / 31.50"
80 cm / 31.50"
44 cm / 17.13"
60 cm / 23.62"
19.5 cm / 7.68"

 80 kg / 177 Lb

 1.45 m³

 18.50 mtl
tessuto cliente /
customer fabric
H 140 cm

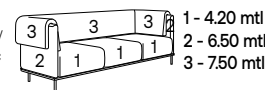

1 - 4.20 mtl
2 - 6.50 mtl
3 - 7.50 mtl

34.41 m²
pelle cliente /
customer pelle

ANGOLO / CORNER

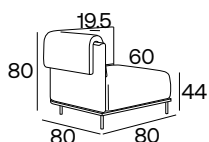

80 cm / 31.50"
80 cm / 31.50"
80 cm / 31.50"
44 cm / 17.13"
60 cm / 23.62"
19.5 cm / 7.68"

 25 kg / 56 Lb

 0.53 m³

 9.00 mtl
tessuto cliente /
customer fabric
H 140 cm

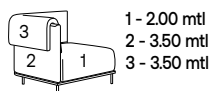

1 - 2.00 mtl
2 - 3.50 mtl
3 - 3.50 mtl

16.74 m²
pelle cliente /
customer pelle

POUF

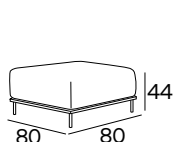

80 cm / 31.50"
80 cm / 31.50"
44 cm / 17.13"

 15 kg / 34 Lb

 0.29 m³

 2.00 mtl
tessuto cliente /
customer fabric
H 140 cm

3.72 m²
pelle cliente /
customer pelle

OMBRA

design GAE AVITABILE

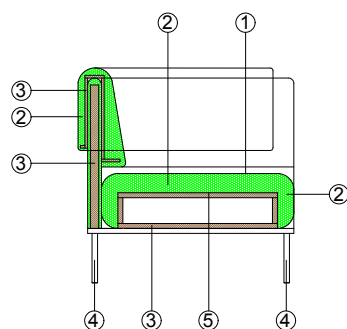

MATERIALI / MATERIALS

- 1 - tessuto/pelle
- 2 - poliuretano espanso indeformabile densità variabili e strato di fibra di dacron® 100 gr
- 3 - telaio in multistrato di legno
- 4 - piedi metallici P 130 a sezione circolare e piano in melaminico a sezione quadrata, L-Ø 2 cm
- 5 - cinghie elastiche intrecciate

- 1 - fabric/leather
- 2 - high resilience polyurethane foam var. densities and dacron® fiber 100 gr layer
- 3 - structural frame in plywood
- 4 - circular metal feet P 130 and square melamine top, W-Ø 2 cm
- 5 - elastic webbing

PIEDI / FEET



CARATTERISTICHE / TECHNICAL FEATURES

SFODERABILITÀ / COVER REMOVAL



VARIANTI / VERSIONS



PIEDI E PIANO / FEET AND TOP

DI SERIE / INCLUDED

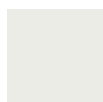

Bianco supremo
U11209 fin. sd
Ral 9010



Magnolia
U11509 fin. sd
Ral 9001



Grigio platino
U12115 fin. sd
Ral 7042



Grigio granito
U12231 fin. vv
Ral 7011



Nero vulcano
U12000 fin. mp
Ral 9004

OPTIONAL / SURCHARGE



Ral colore a scelta
Ral color of your
choice

RIVESTIMENTI CONSIGLIATI / SUGGESTED FABRICS

JAGUARD	BIELASTICO / BIELASTIC	LANA / WOOL	TESS. SPALMATO / COATED FABRIC	VELLUTO / VELVET	MICROFIBRA / MICROFIBER	BOUCLÉ	PELLE / LEATHER
CHILI Cat. extra	B-CHEW BIT Cat. top	EUROPOST 2 Cat. elegant	VINTAGE Cat. extra	LEMMING 29500 Cat. elegant	MYSTIQUE Cat. extra	VOLT Cat. super	MOON Cat. extreme
MINI MELANGE Cat. lusso	MIRAGE Cat. lusso	FENICE Cat. extra	FLEXO FR Cat. a	8336/8336 LT Cat. lusso/extra			FLOWER Cat. elegant
OCEANIC Cat. elegant	NAUTILUS Cat. extra	HERO 2 Cat. extreme	ZEUS Cat. a	CINIGLIA / CHENILLE			BASIC Cat. elegant
ONE Cat. a	UNIFORM MELANGE Cat. plus			AMARA 83974 Cat. elegant			
PANAREA OUTDOOR Cat. a							
RADIO Cat. a							
STEELCUT TRIO 3 Cat. top							
STEP Cat. extra							
SUMMER/SUMMER FR Cat. a							