

REF. 3.086

CP1803-E-NOGAL Aparador

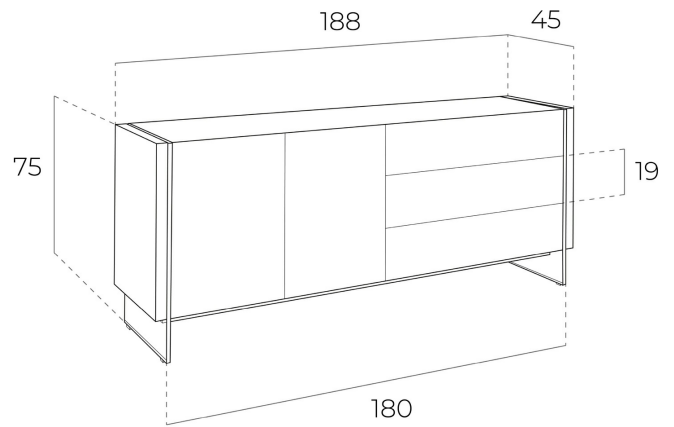

MEDIDAS

Medidas: 188 x 45 x 75 cm.

Peso: 101 Kg.

EMBALAJE

190 x 53 x 71 cm. / 81 Kg.

84 x 52 x 8 cm. / 24 Kg.

VOLUMEN

0,92 m³

PRODUCTO

Chapa Nogal

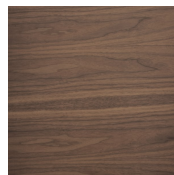

PATAS

Material Patas: Cristal-TTE

