











A		M8x45	X6
B		M6x13	X8
C		M8x30	X8
D		M8x16	X2
E		M6x25	X1
F		Ø8xØ16	X16

Finish

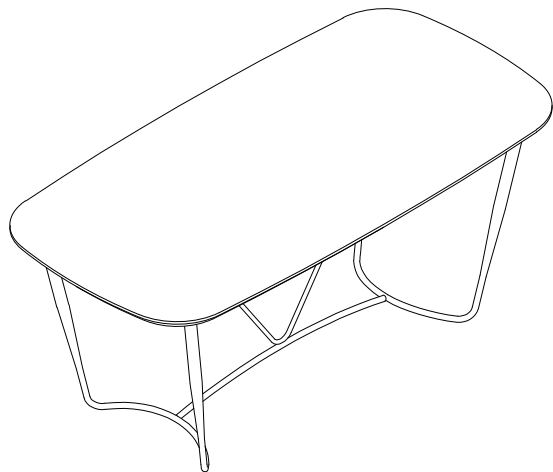

0249002

 x2	 0:20	 G 5# x1
--	--	---

Step:1

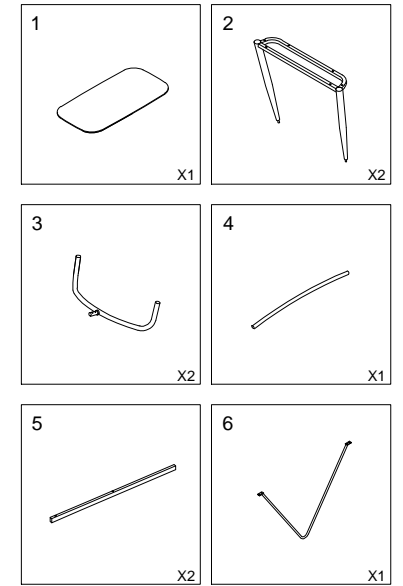
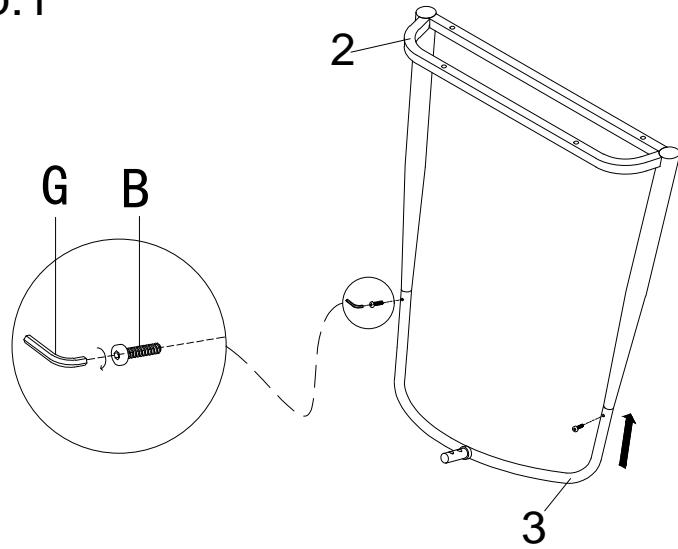

Step:2

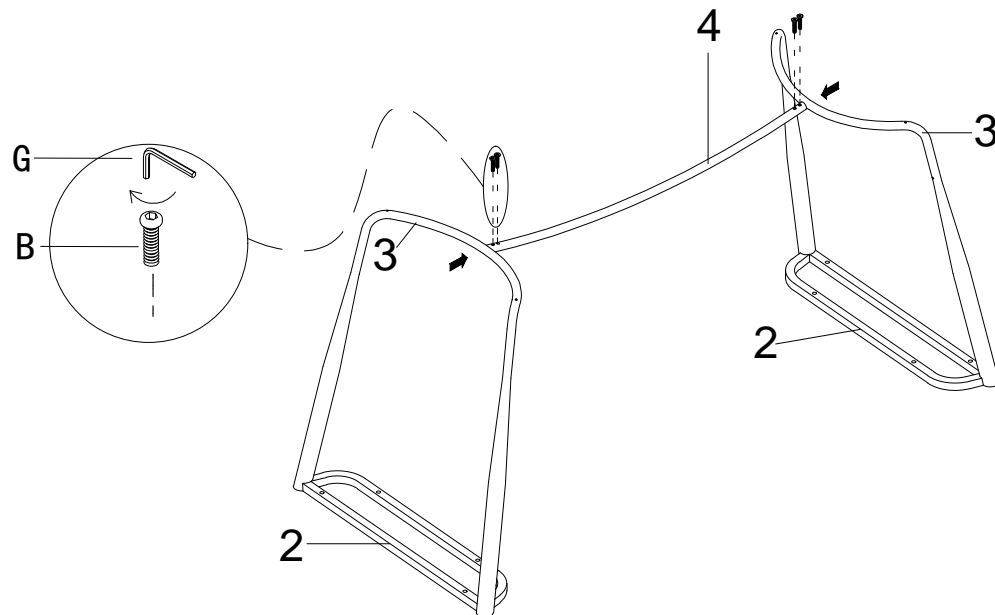

Step:3

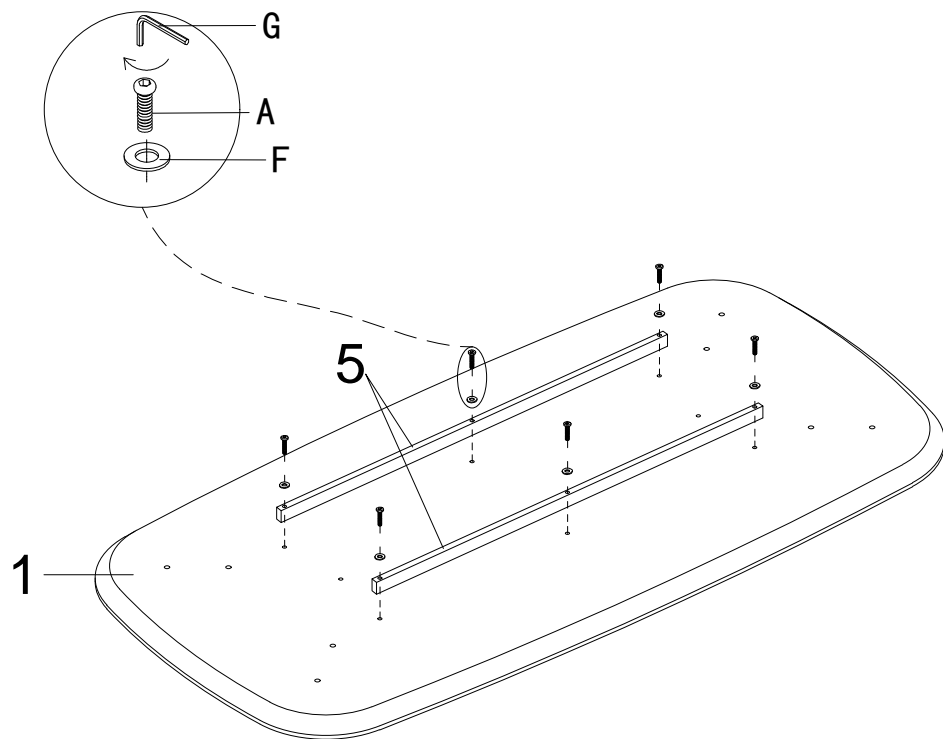

Step:4

