

Step 1

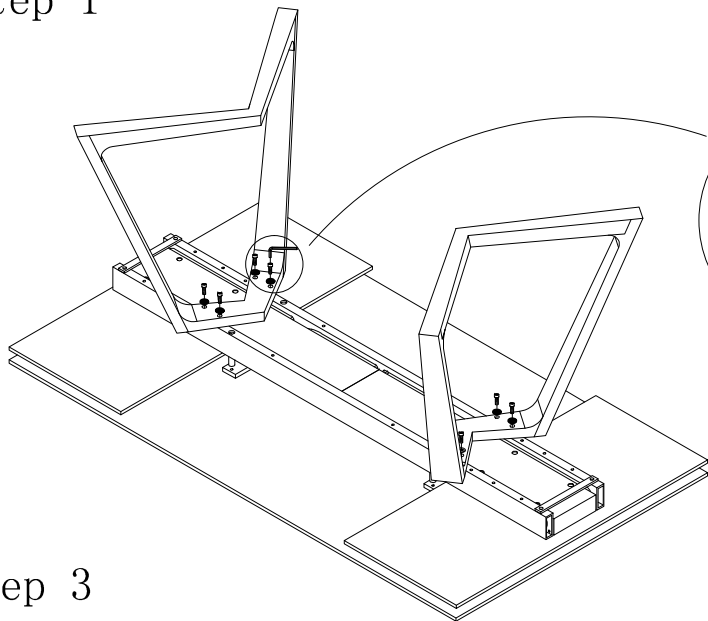

Step 2

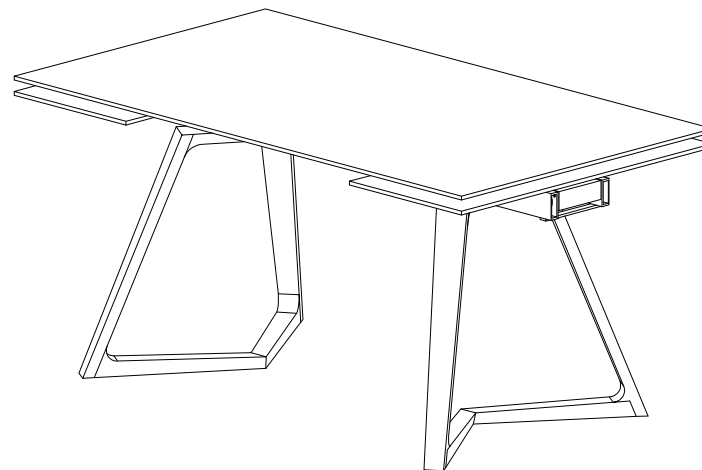
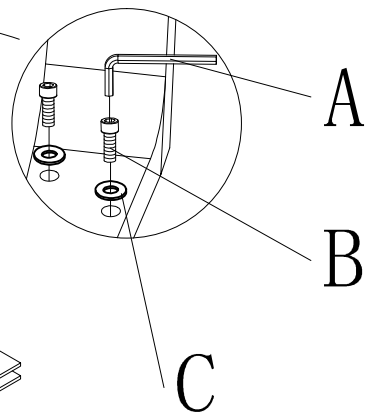

Step 3

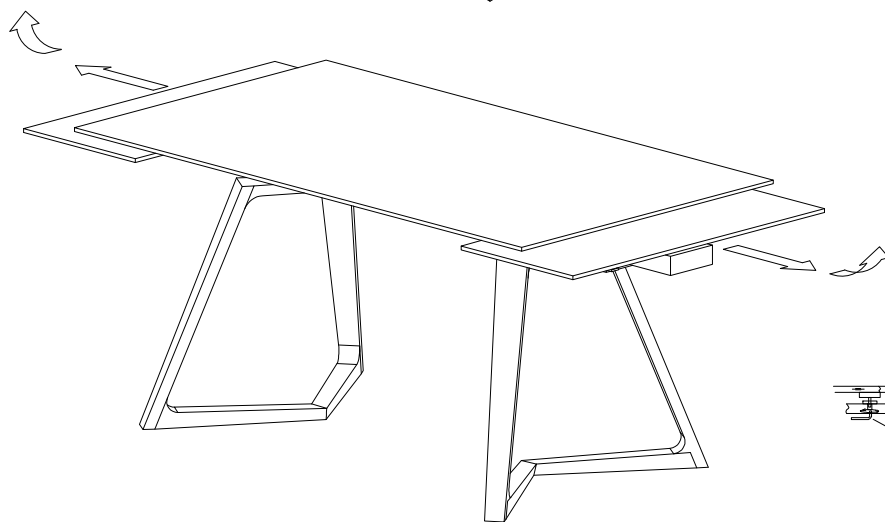



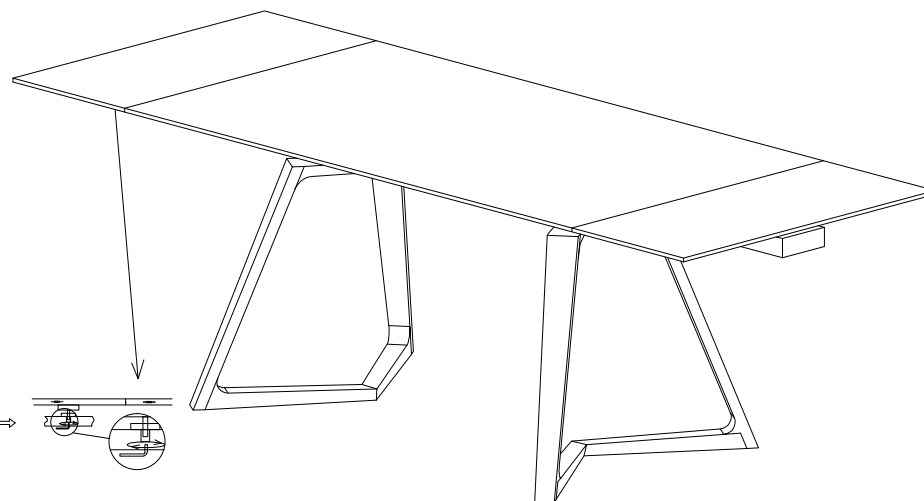

Finish



Use wrench D to turn the rod, then adjust screw to make the glass on the flat. (after adjust please lock the screw rod.)

DT8765ZW-3

NO.	A	B	C	D
TYPE	 6#	 8x45	 8#	 8#
QTY	1pc	8pcs	8pcs	1pc