

20.21.1501.01

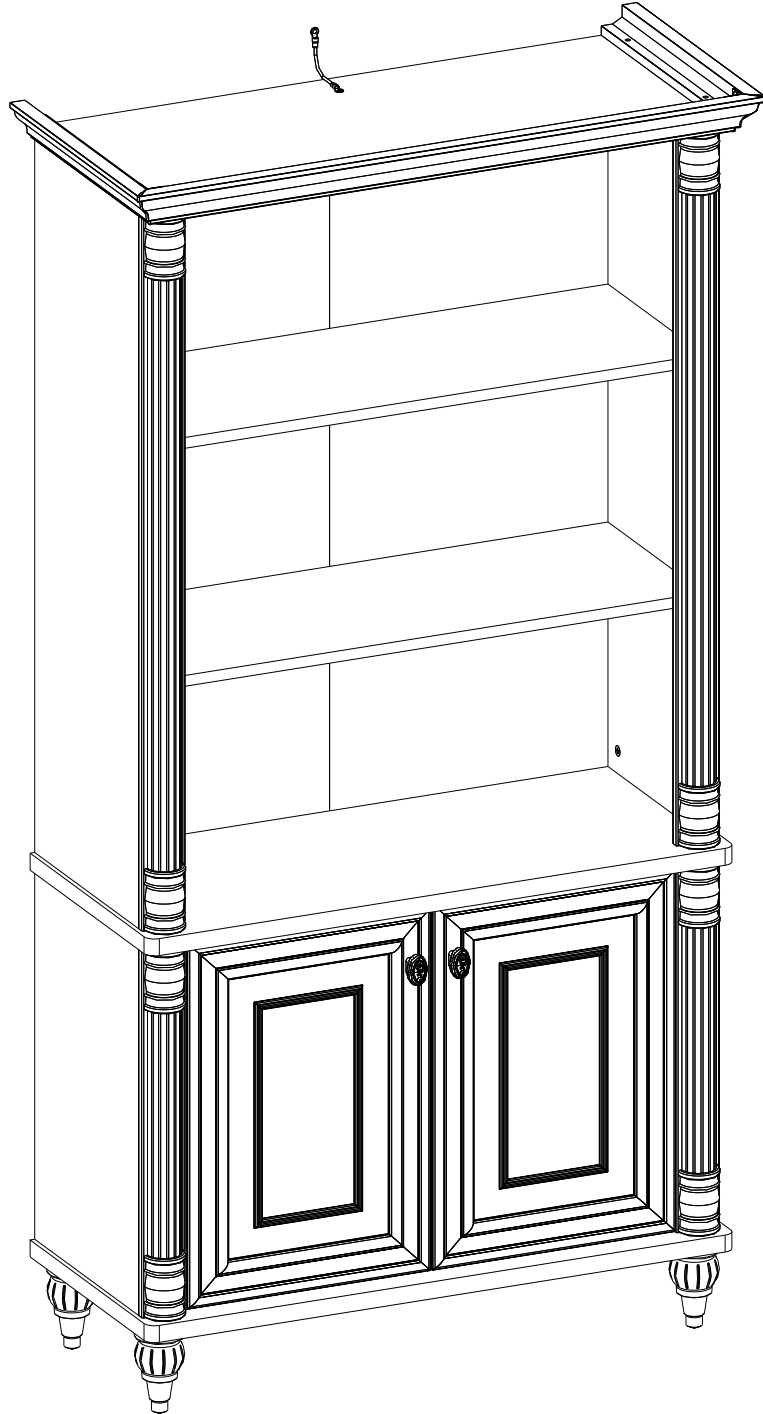

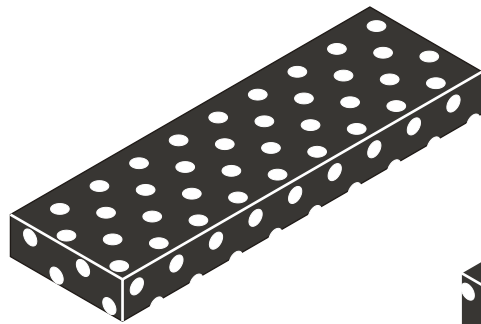

2 / 1

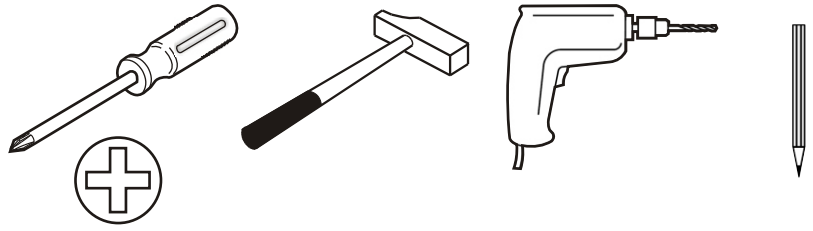
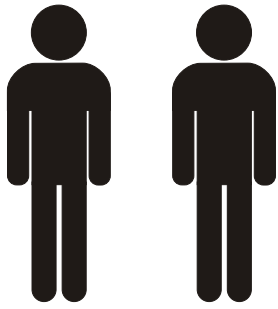
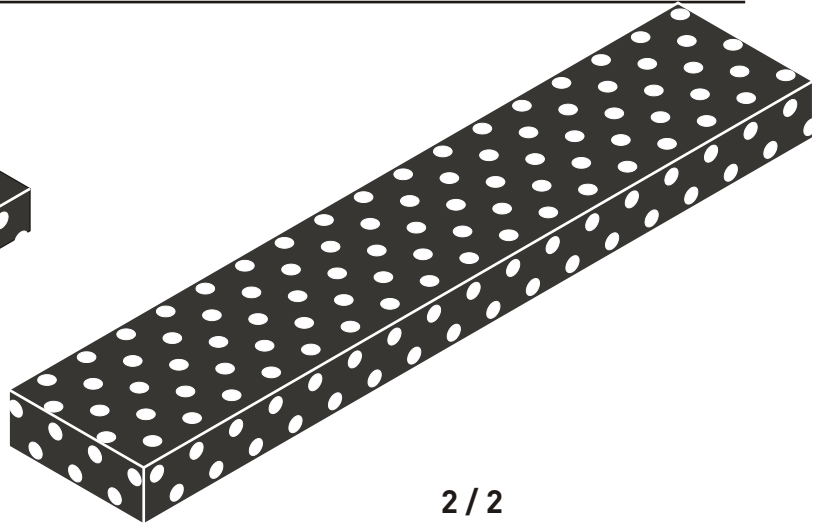

2 / 2

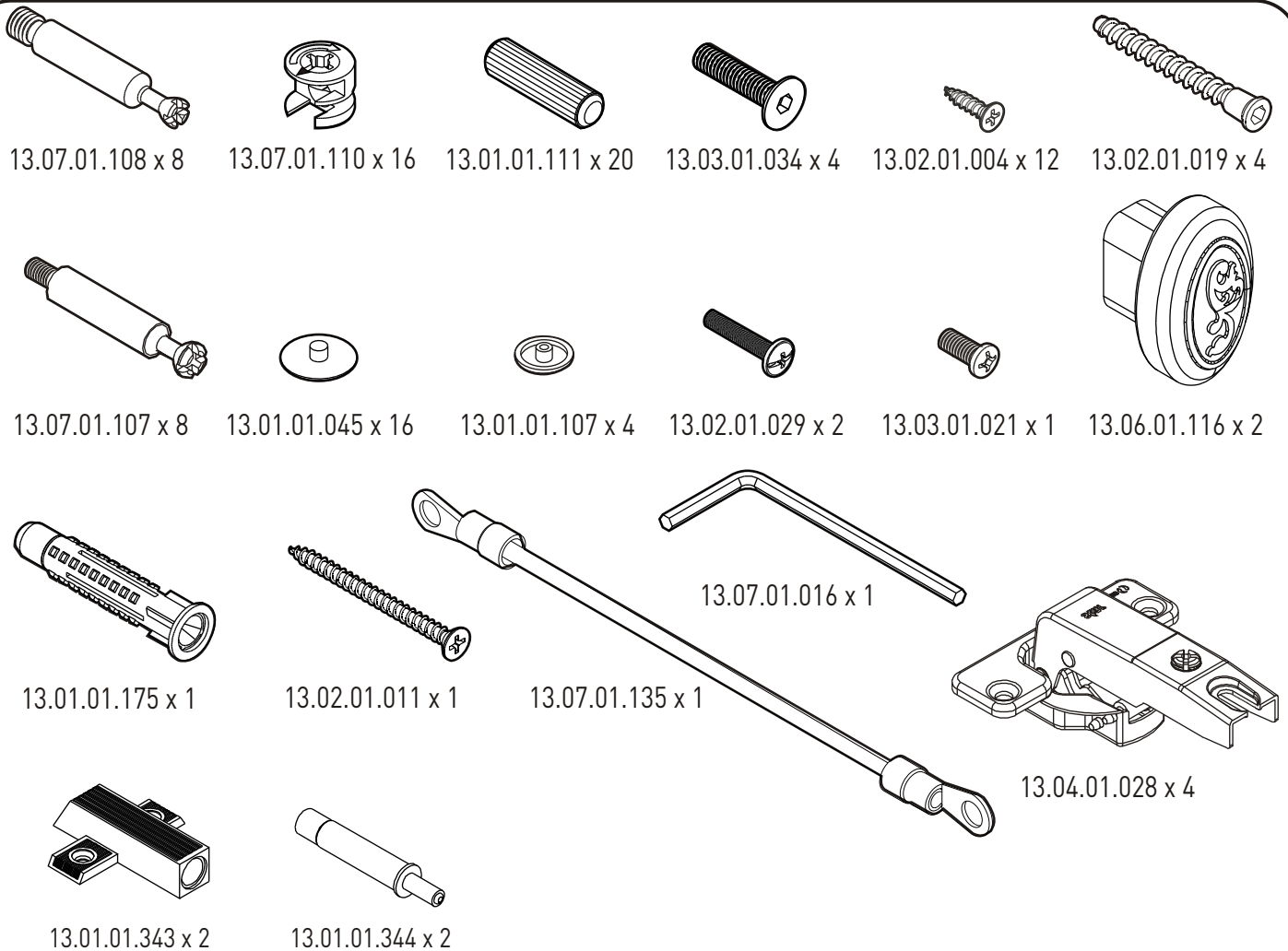

2 / 1

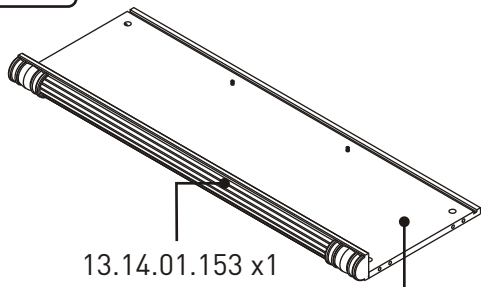

13.14.01.153 x 1

18.21.1501.008 x 1

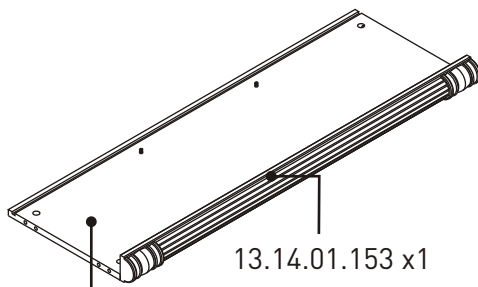

13.14.01.153 x 1

18.21.1501.006 x 1

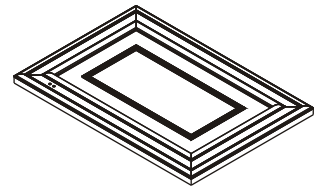

18.21.1501.051 x 1

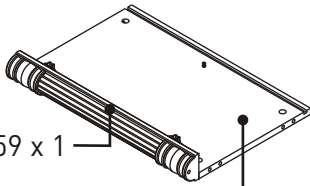

13.14.01.259 x 1

18.21.1501.054 x 1

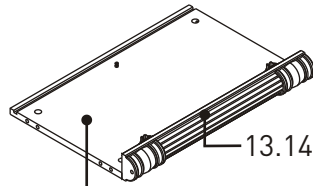

13.14.01.259 x 1

18.21.1501.052 x 1

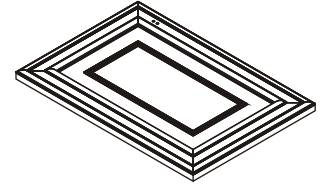

18.21.1501.050 x 1

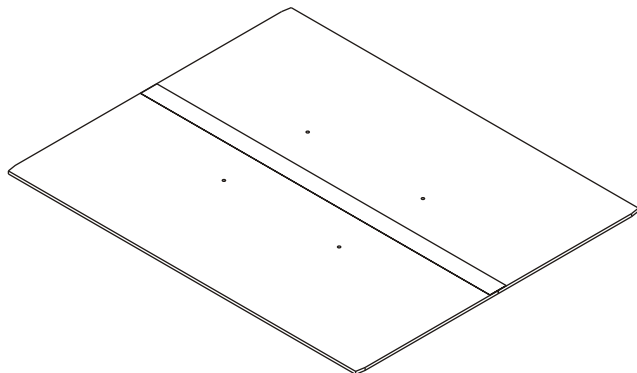

18.21.1501.018 x 1

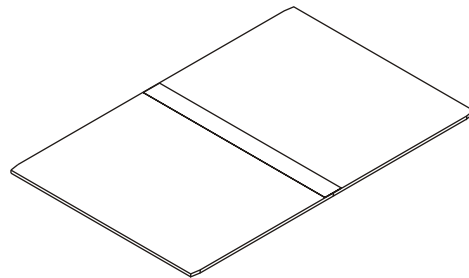

18.21.1501.057 x 1

2 / 2

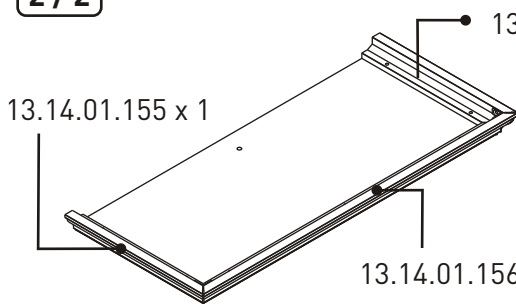

13.14.01.157 x 1

13.14.01.155 x 1

13.14.01.156 x 1

18.21.1501.009 x 1

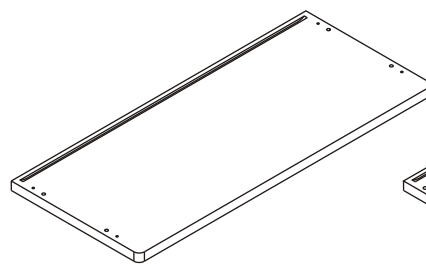

18.21.1501.005 x 1

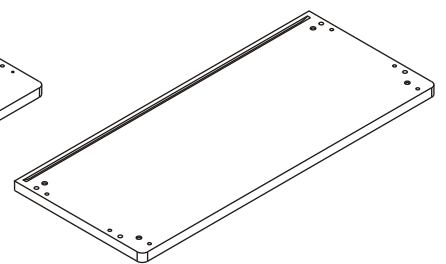

18.21.1501.001 x 1

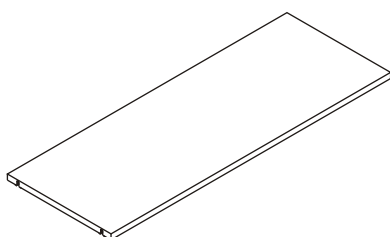

18.21.1501.016 x 3



13.01.01.293 x 4

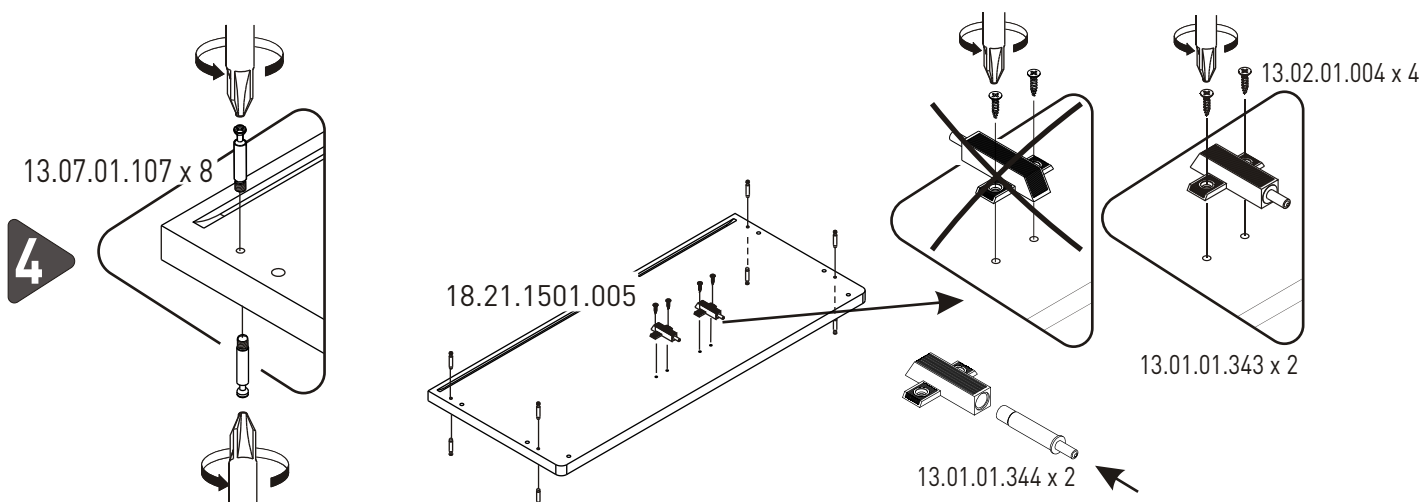
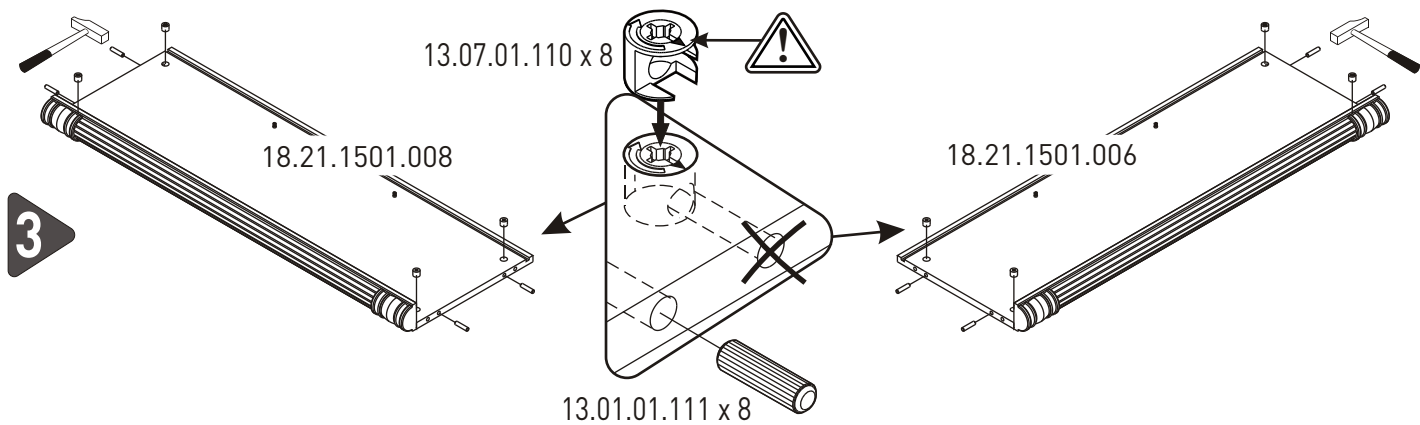
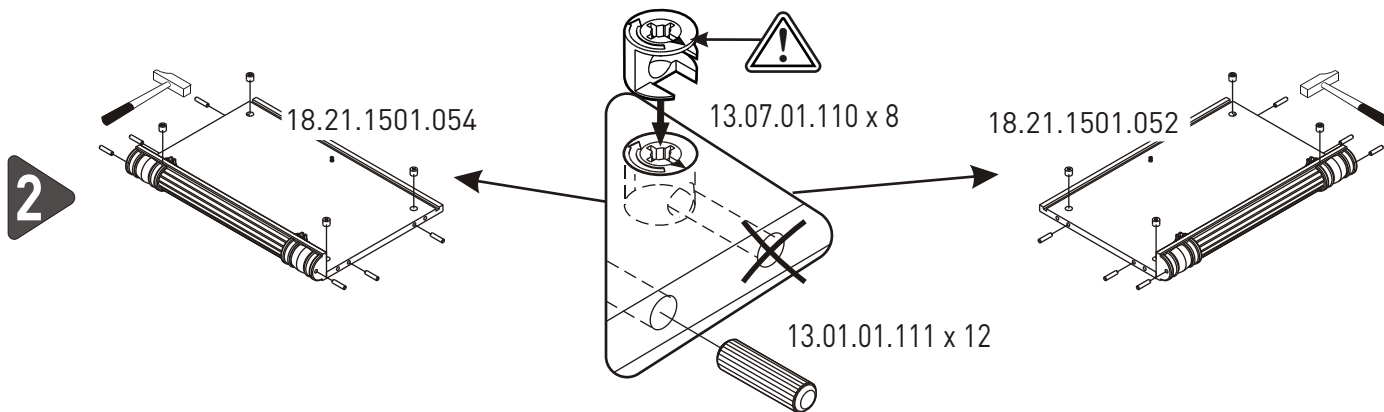
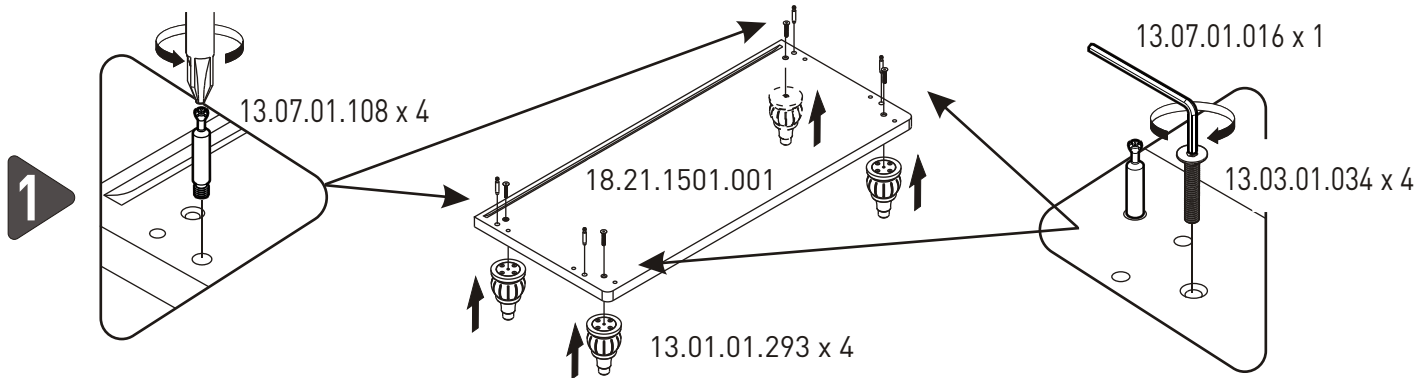

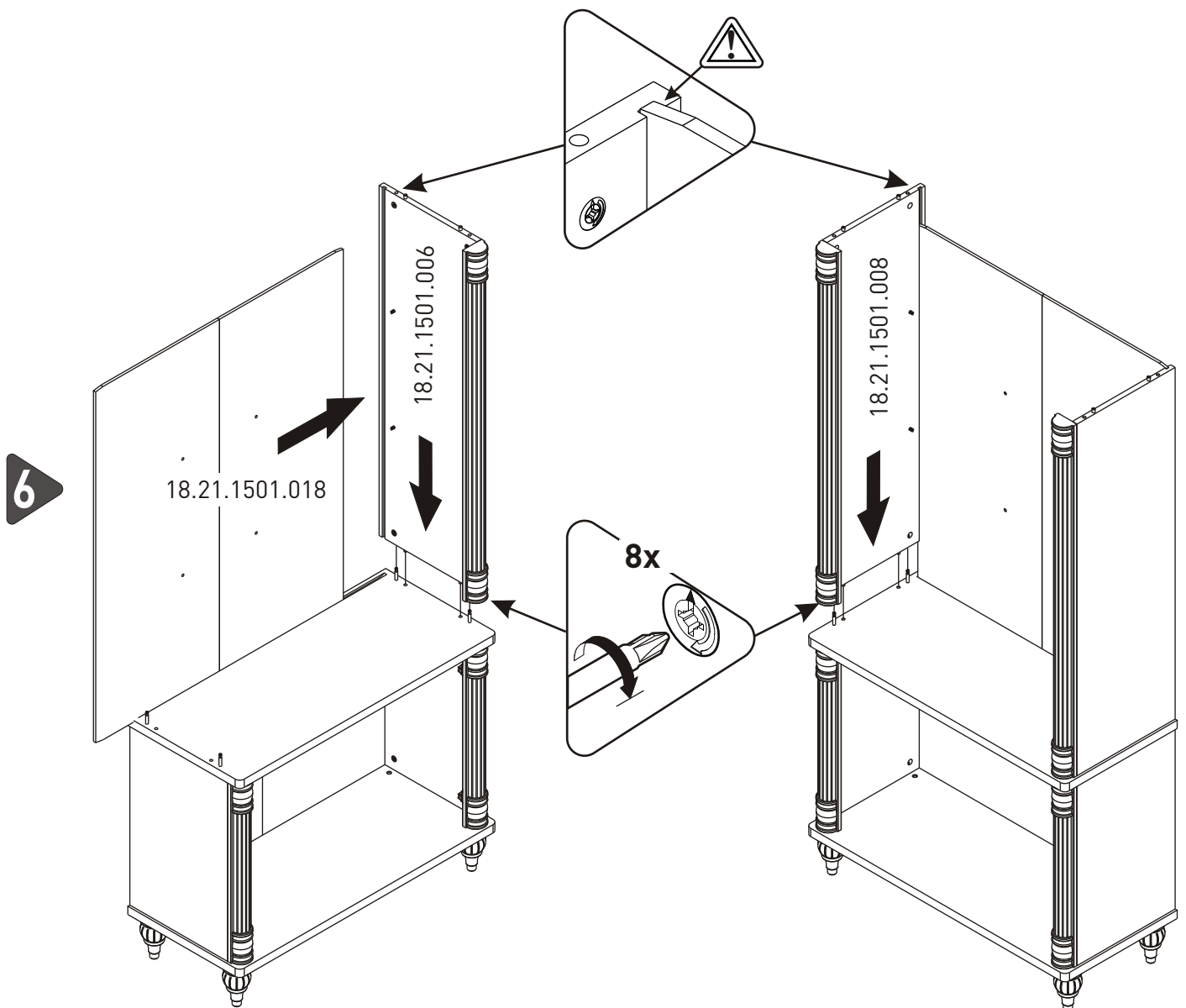
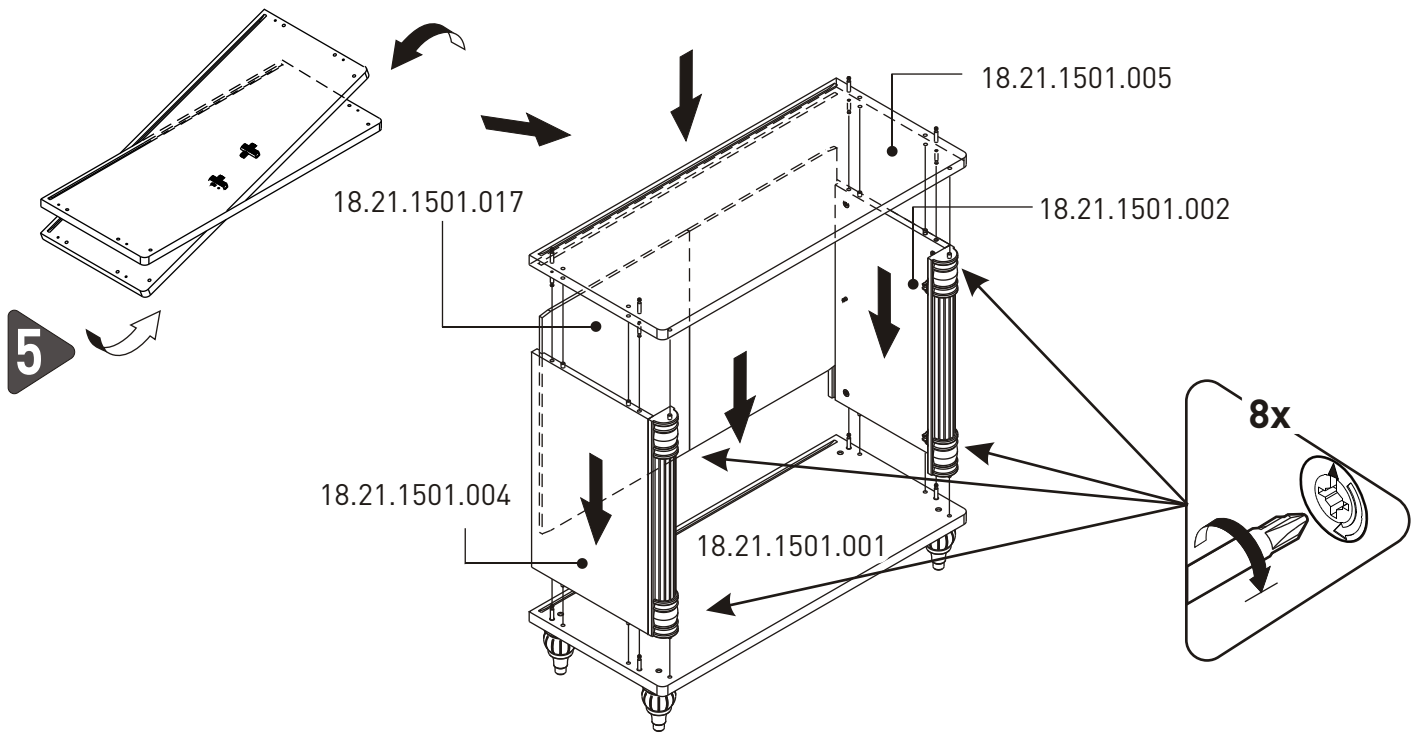

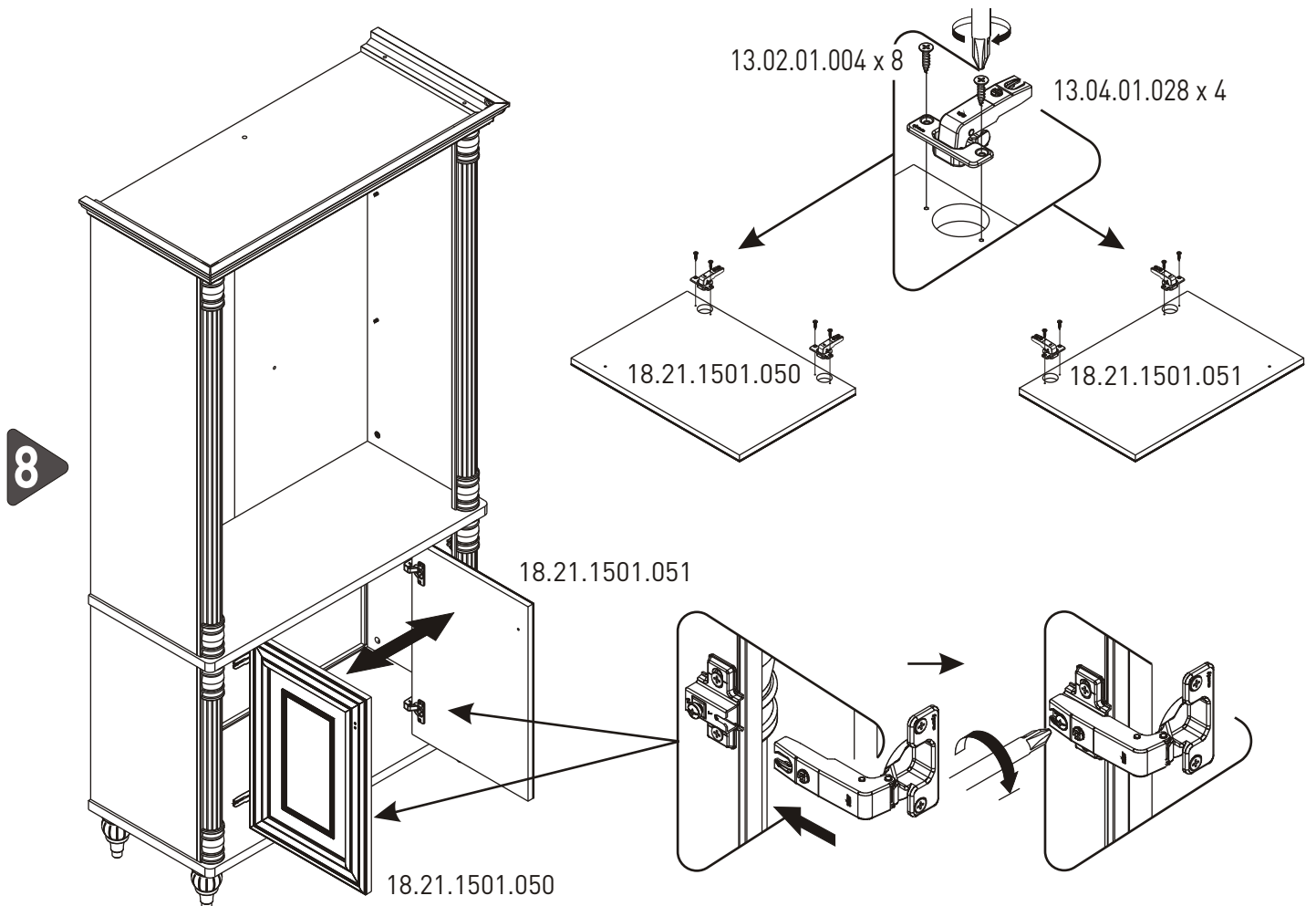
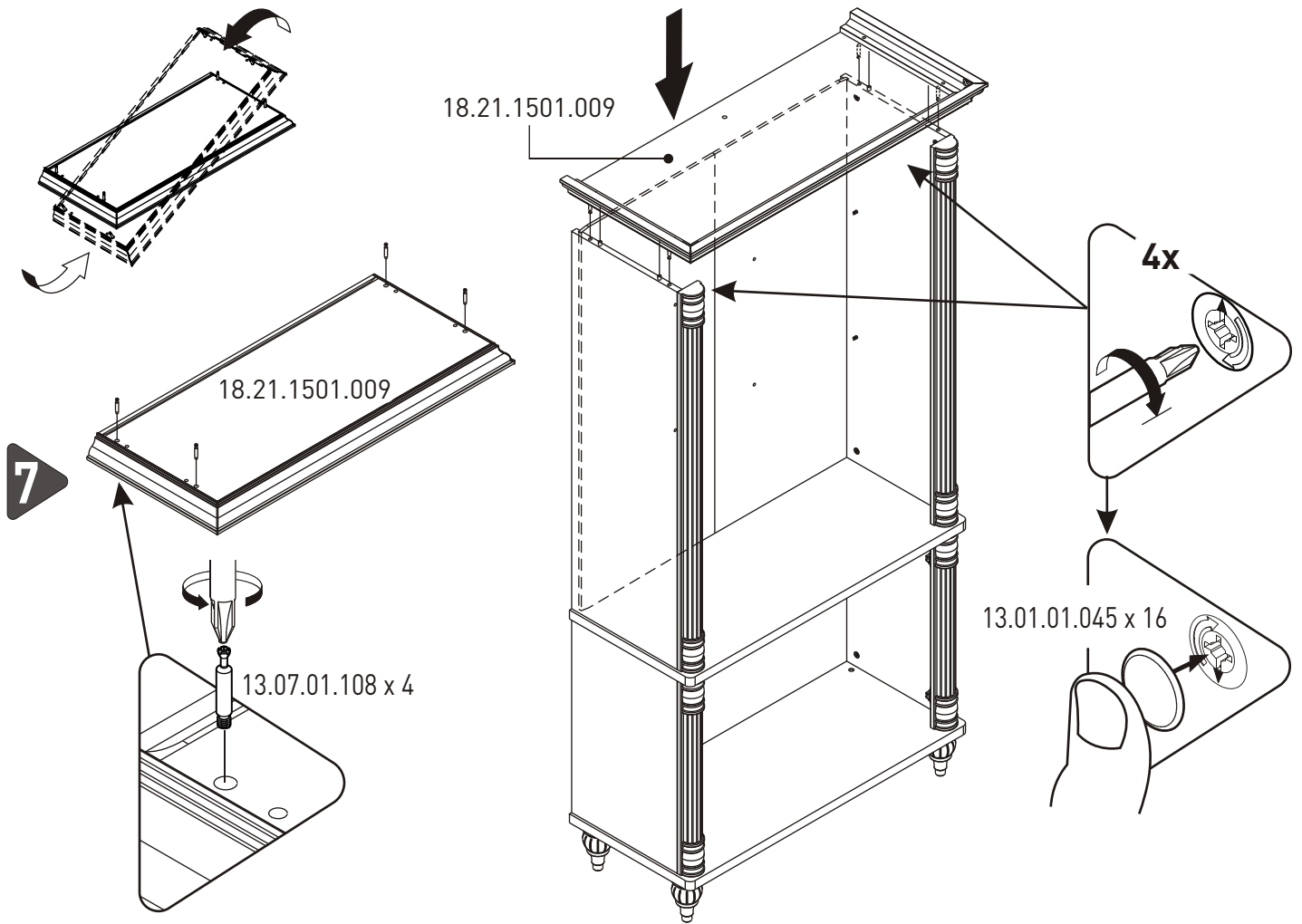

9

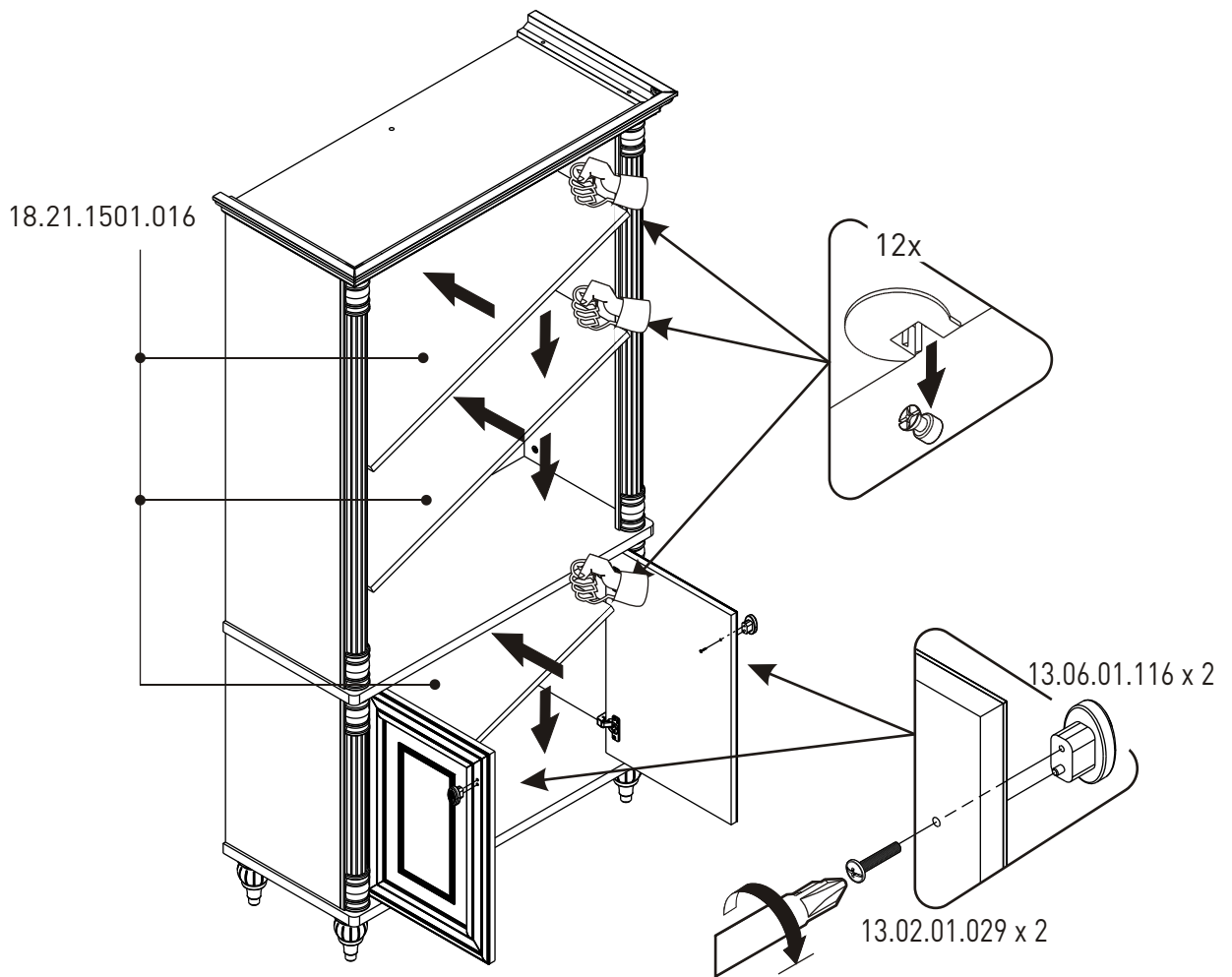

10

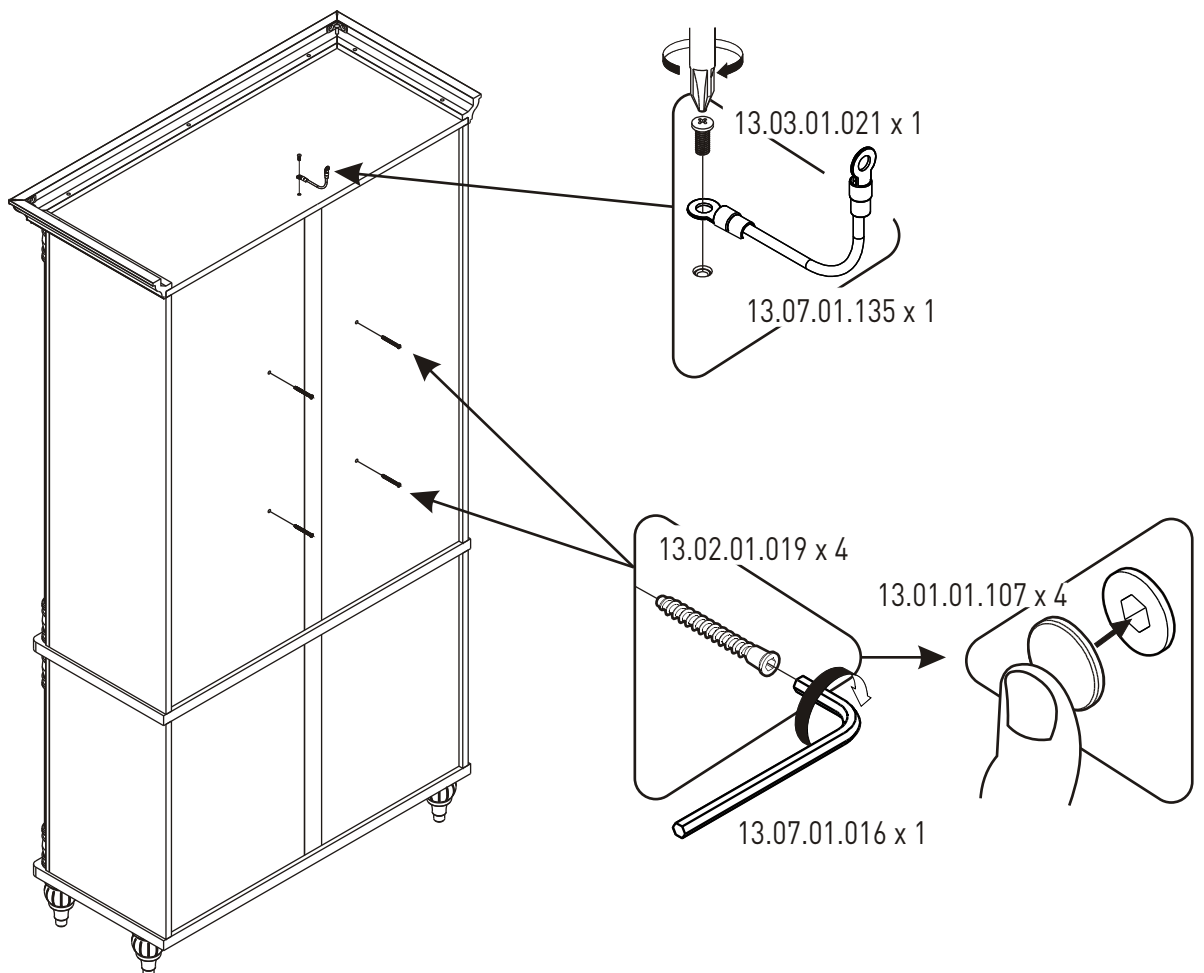

11

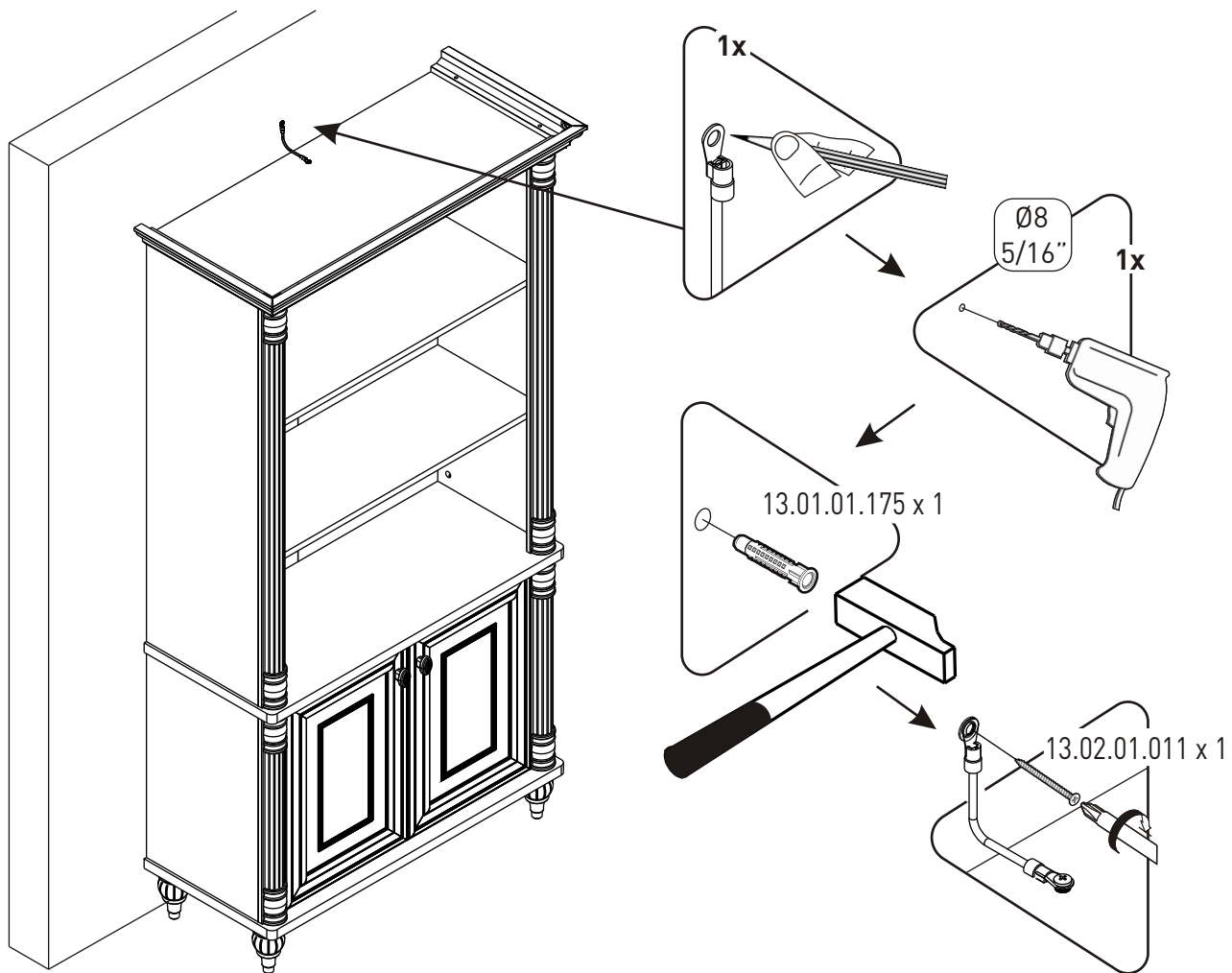

i

