







A	 	x6
B	 	x4
C		x4
D		x2

Finish



0258004

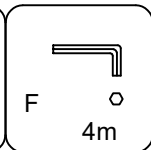
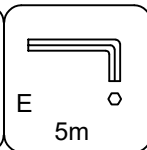
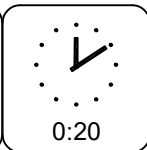
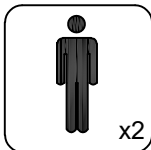

Step:1

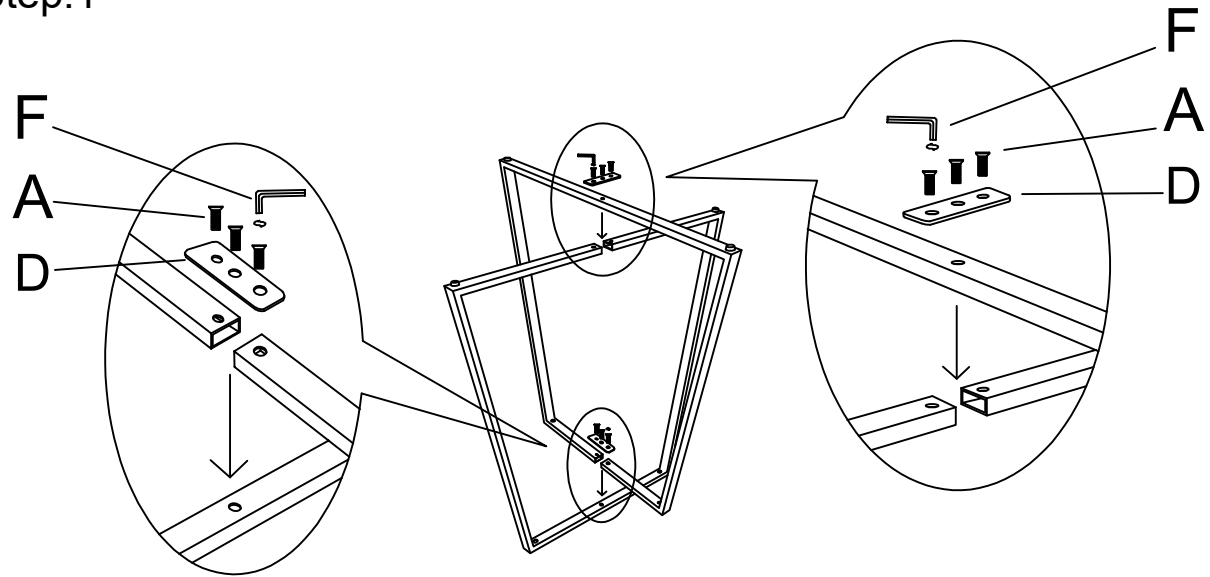

Step:2

